

1500L - Below ground grease traps

- Manufactured from durable polyethylene
- Cleanable, smooth internal surface
- AS 3996 compliant access covers with concrete collars
- Light for easy transport and installation

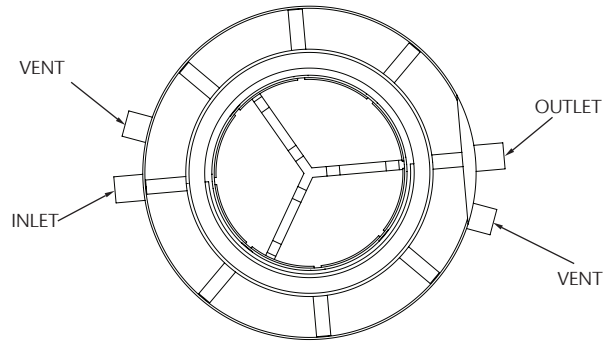

Top View

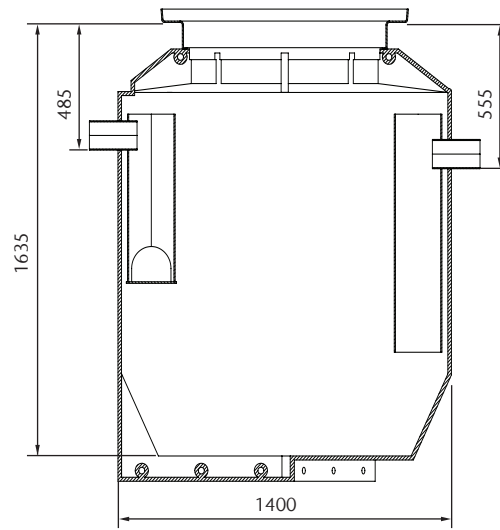

Side View

Lipumax grease traps

Part No.	Description	Empty Weight (kg)	Diameter of unit	Height of unit	Invert of outlet to top	Invert of inlet to top
143268	Lipumax PPE 1500L	128	1400	1635	555	485

Specifications

Grease trap shall be ACO Passavant Lipumax - PPE 1500L below ground grease trap, part number 143268. The grease trap shall be supplied with Part No. _____ cover & collar / Part No. _____ cover, collar & riser tube / Part No. _____ cover, collar, riser tube & load distribution plate. Grease trap shall be supplied and manufactured by ACO and installed in accordance with local codes and Standards.

ACO Specification Information

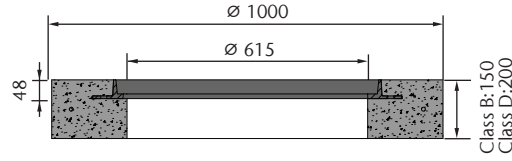

Cover and collar

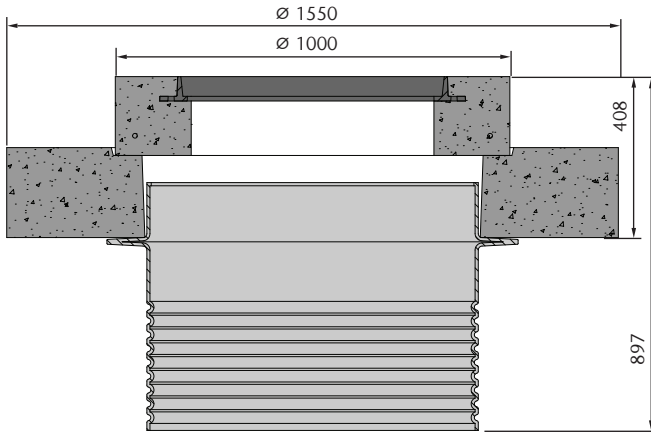

Cover, collar, riser tube and load distribution plate

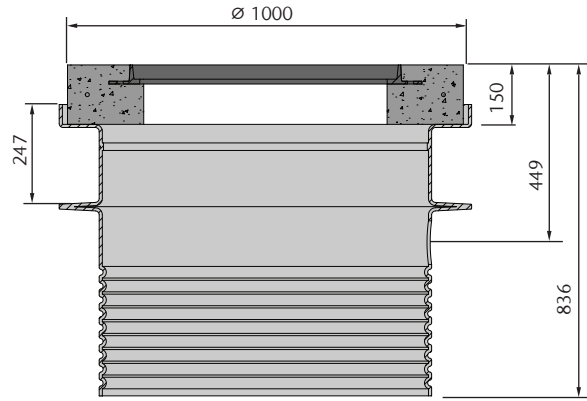

Cover, collar and riser tube

Note: all dimensions are in mm.

Lipumax access cover assembly

Cover Type	Cover & Collar		Cover, collar, riser tube*				Cover, collar, riser tube* & load distribution plate			
	Part No.	Weight (kg)	Short		Long		Short		Long	
	Part No.	Weight (kg)	Part No.	Weight (kg)	Part No.	Weight (kg)	Part No.	Weight (kg)	Part No.	Weight (kg)
Rhinocast Class B	142120	215	142781	237	142951	262				
Rhinocast Class D	142099	366	142782	388	142952	413	142299	1121	142953	1146

* Riser tube only: 142350 (short); 142970 (long)