

Specification Information Sheet

EcoJet 1000L
Part no. 142090

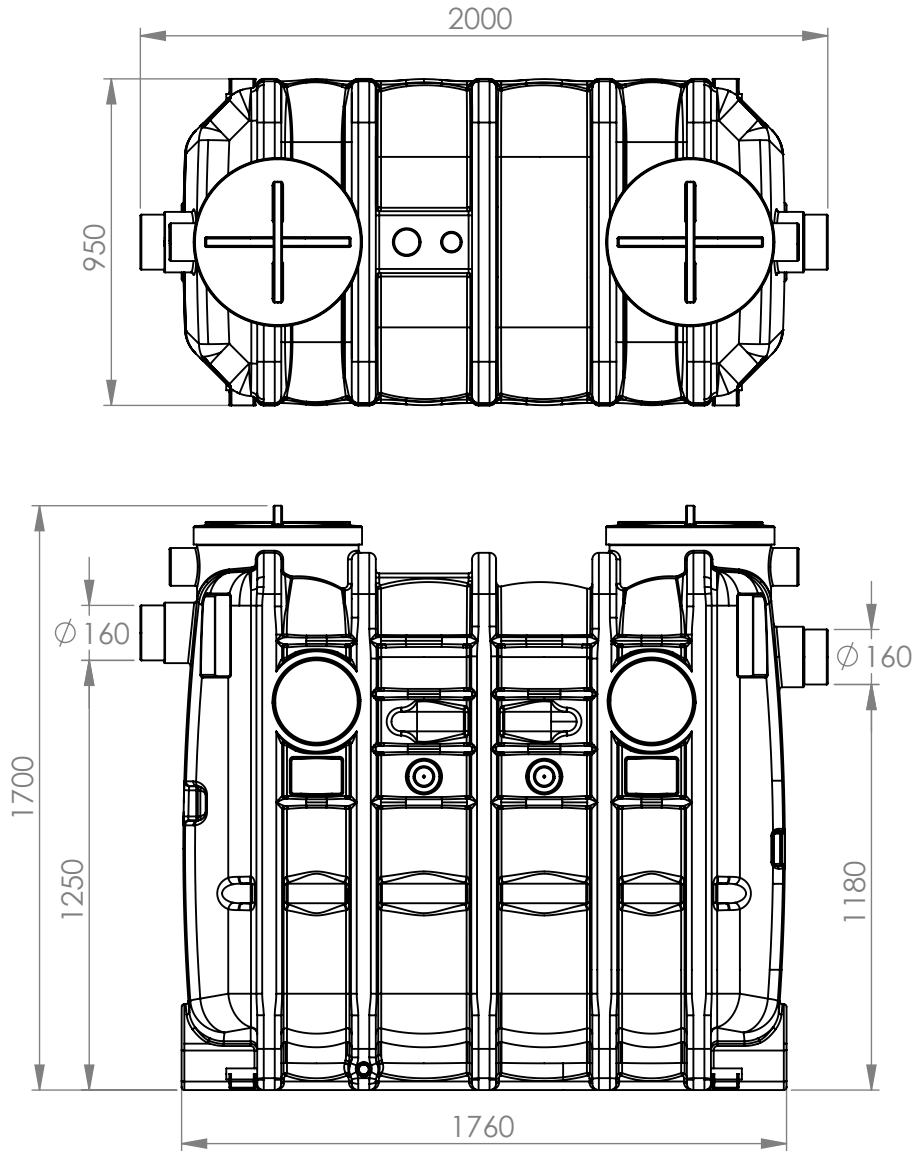

Specification Clause

Grease trap shall be ACO Passavant EcoJet 1000L above ground grease trap, part number 142090.

Grease trap shall be supplied and manufactured by ACO and installed in accordance with local codes and Standards.

The grease trap shall be manufactured in accordance with EN 1825 from polyethylene in compliance with local codes and Standards. The effluent quality must comply with EN 1825.

www.acopassavant.com.au
Ph: 1300 765 266 (Australia)
Ph: +61 2 4747 4000 (International)

*All dimensions in mm