

Specification Information Sheet

Lipumax-P 720L
Part no. 142094

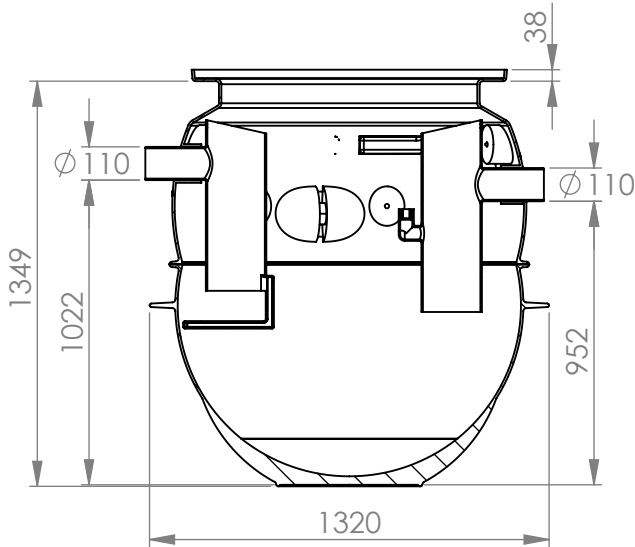

Cover and collar

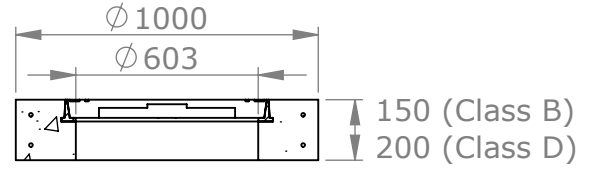

SAKU® Class B: 142296
 Rhinocast® Class B: 142120
 Rhinocast® Class D: 142099

Cover, collar and riser tube

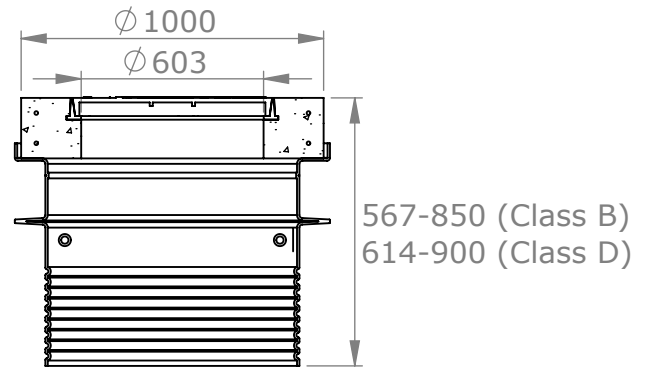

SAKU® Class B: 142780
 Rhinocast® Class B: 142781
 Rhinocast® Class D: 142782

Cover, collar, riser tube and load distribution plate

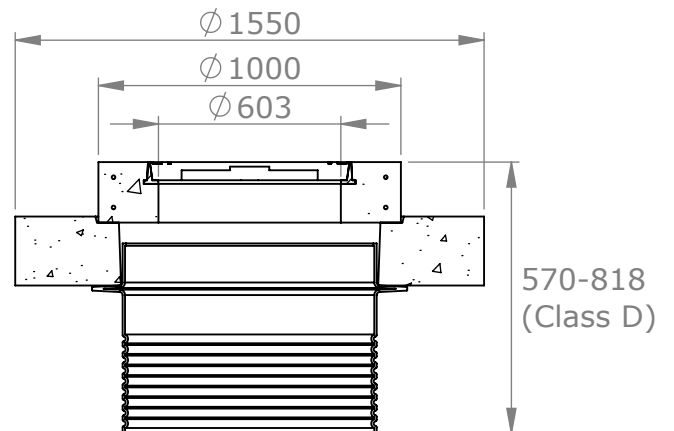

Rhinocast® Class D: 142299

www.acopassavant.com.au
Ph: 1300 765 266 (Australia)
Ph: +61 2 4747 4000 (International)

*All dimensions in mm

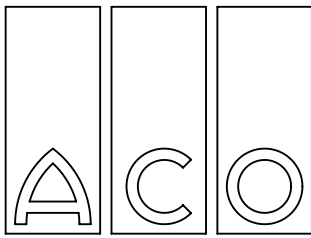

Specification Information Sheet

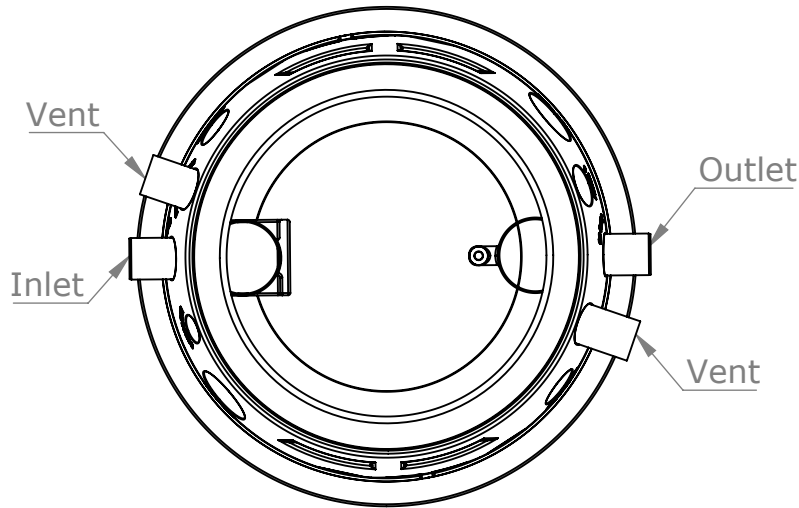

Specification Clause

Grease trap shall be ACO Passavant Lipumax-P 720L below ground grease trap, part number 142094. The grease trap shall be supplied with a SAKU® Class B 80kN (AS 3996) cover and reinforced concrete collar, part number 142119 / Rhinocast Class B 80 kN (AS 3996) cover and reinforced concrete collar, part number 142120 / Rhinocast Class D 210 kN (AS 3996) cover, reinforced concrete collar and load distribution plate, part number 142299 / Rhinocast Class D 210 kN (AS 3996) cover and reinforced concrete collar to suit engineered slab details, part number 142099.

Grease trap shall be supplied and manufactured by ACO and installed in accordance with local codes and Standards.

The grease trap shall be manufactured in accordance with EN 1825 from polyethylene. The design shall feature a rib-structure to key into concrete and manufactured in one piece. The effluent quality must comply with EN 1825.